

## FOCUS 2

### MOLECULES

**2A.2** (a) 5; (b) 8; (c) 12; (d) 7

**2A.4** (a) [Ar] 3d<sup>1</sup>; (b) [Ar] 3d<sup>5</sup>; (c) [Kr] 4d<sup>10</sup>; (d) [Xe]

**2A.6** (a) [Kr]; (b) [Xe] 4f<sup>14</sup>5d<sup>5</sup>; (c) [Xe]; (d) [Ar]

**2A.8** (a) Ca: [Ar] 4s<sup>2</sup>, Ti<sup>2+</sup>: [Ar] 3d<sup>2</sup>; V<sup>3+</sup>: [Ar] 3d<sup>2</sup> In the d block, the energies of the n-1 d-orbitals lie below those of the ns-orbitals. Therefore, when V and Ti form ions they lose their 4s electrons before losing their 3d electrons. (b) Ca: no unpaired electrons; Ti<sup>2+</sup>: two unpaired electrons; V<sup>3+</sup>: two unpaired electrons. (c) Ti<sup>3+</sup>: [Ar] 3d<sup>1</sup> no neutral atom has this electron configuration.

**2A.10** (a) Au<sup>3+</sup>; (b) Os<sup>3+</sup>; (c) I<sup>3+</sup>; (d) As<sup>3+</sup>

**2A.12** (a) Cr<sup>2+</sup>; (b) Ag<sup>2+</sup>; (c) Zn<sup>2+</sup>; (d) Pb<sup>2+</sup>

**2A.14** (a) 4d; (b) 3p; (c) 5p; (d) 4s

**2A.16** (a) +1; (b) -2; (c) +2; (d) -3; (e) -1

**2A.18** (a) 2; (b) 5; (c) 3; (d) 6

**2A.20** (a) [Ar]; no unpaired electrons; (b) [Ar]3d<sup>7</sup>; three unpaired electrons;  
(c) [Kr]; no unpaired electrons; (d) [Kr]; no unpaired electrons



## 2B.4

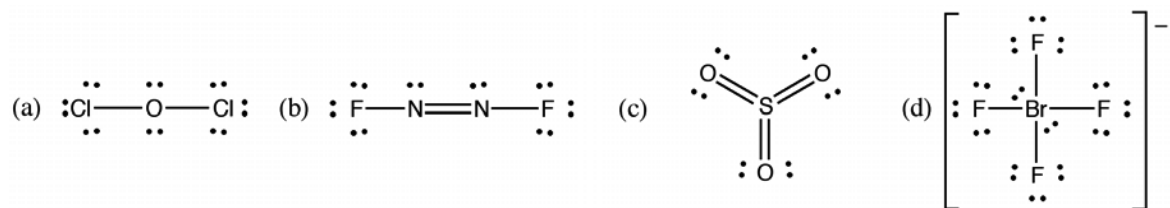

## 2B.6

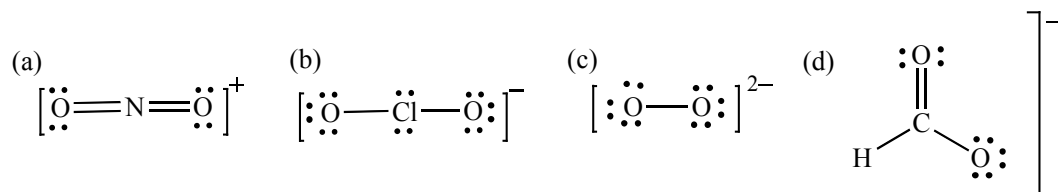

**2B.8** The structure has a total of 32 electrons; of these, 14 are accounted for by the chlorines ( $2 \text{ Cl}'\text{s} \times 7$  valence electrons each); and 12 are accounted for by the oxygens ( $2 \text{ O}'\text{s} \times 6$  valence electrons each). This leaves 6 electrons unaccounted for; these must come from E. Therefore, E must be a member of the oxygen family, and since it is a fourth period element, E must be selenium (Se)

## 2B.10

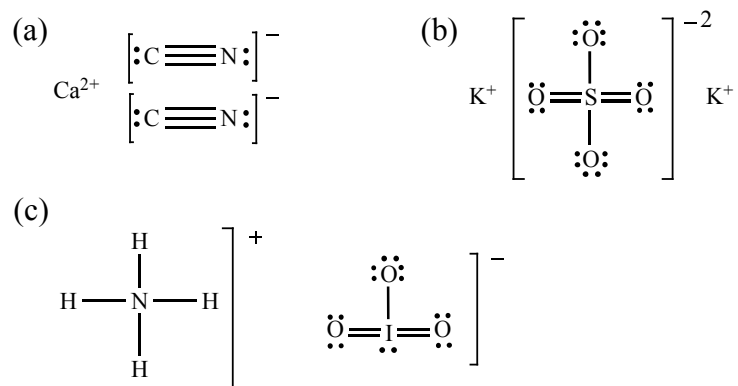

80 Focus 2 Molecules

2B.12

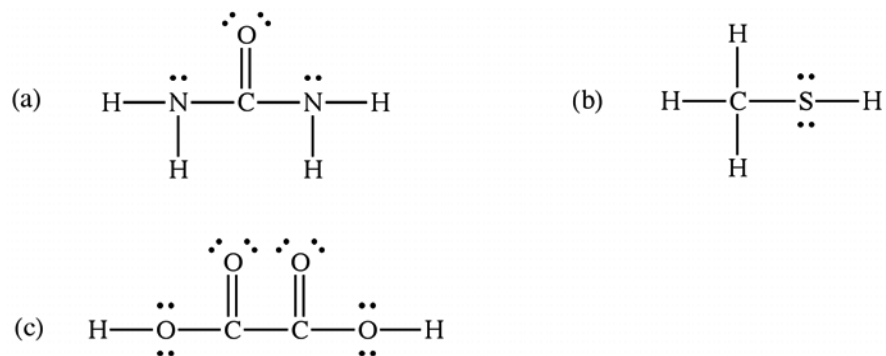

2B.14

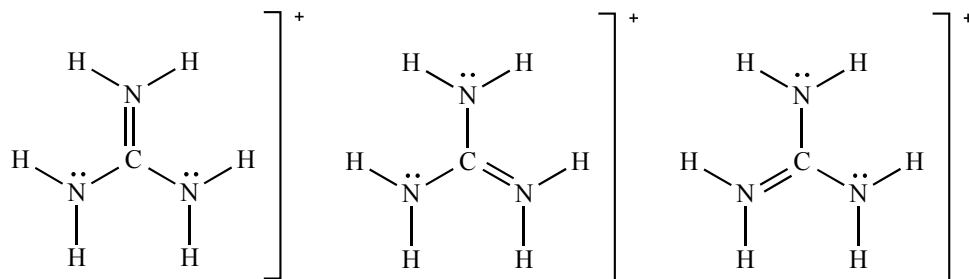

2B.16

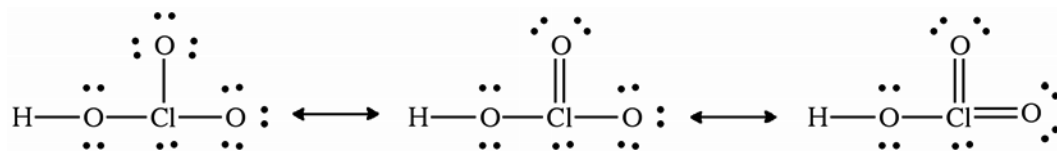

2B.18 There are four possible resonance structures for  $\text{Se}_4^{2+}$  (the seleniums have been numbered for clarity):

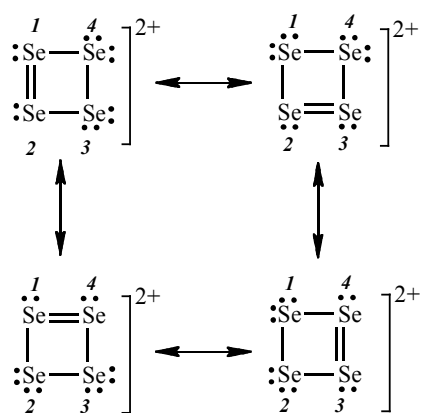

## 2B.20

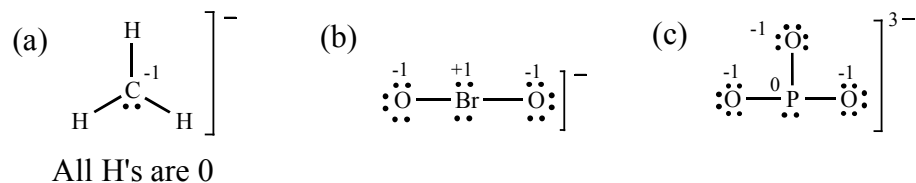

## 2B.22 The three possible Lewis structures for NOF are:

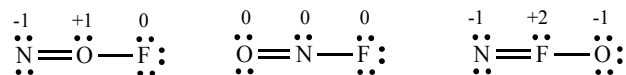

The second structure is the most likely since all atoms have zero formal charge.

## 2B.24

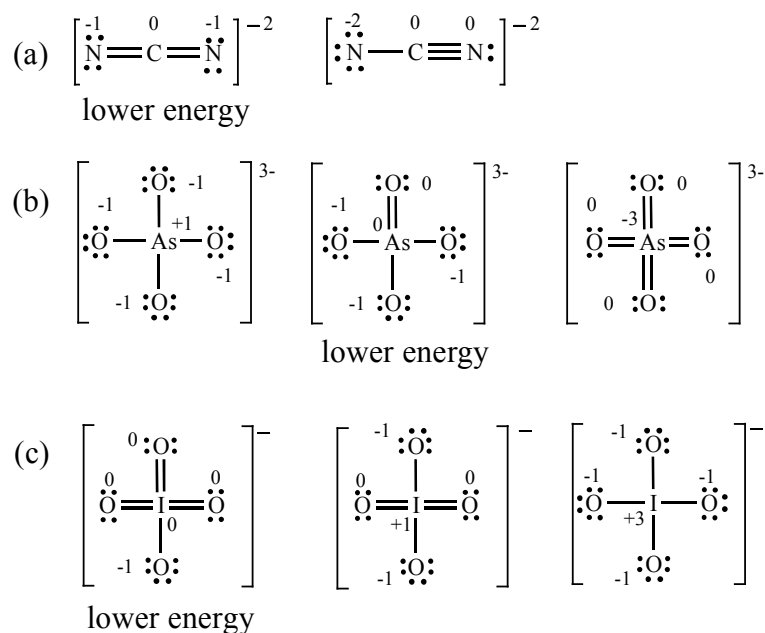

2C.2 Radicals are species with an unpaired electron; therefore, only (a) and (d) are radicals since they have an odd number of electrons while (b) and (c) have an even number of electrons, which allows Lewis structures to be drawn with all electrons paired.

2C.4 (a) The formate ion has two resonance structures, each having an oxygen with a formal charge of  $-1$ :

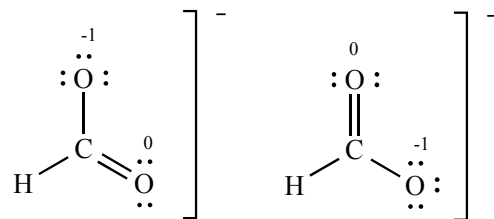

(b) The hydrogen phosphite ion has one Lewis structure that obeys the octet rule, the first structure shown below. Including one double bond to oxygen lowers the formal charge of P from  $+1$  to  $0$ . Three resonance forms include this contribution.

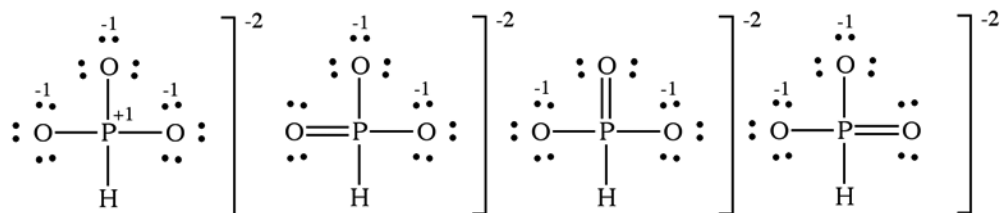

(c) The bromate ion has one Lewis structure that obeys the octet rule, the first structure shown below. Including double bonds to two of the oxygens lowers the formal charge of Br from  $+2$  to  $0$ . Three resonance forms include this contribution.

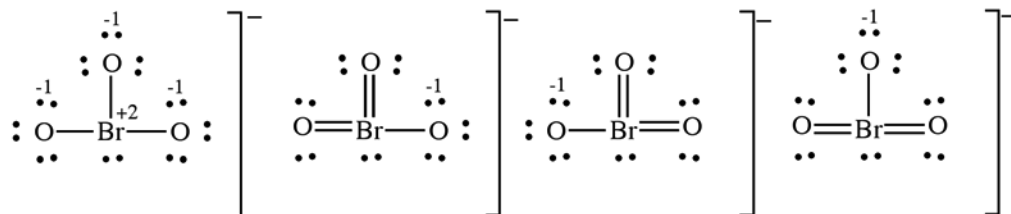

(d) The selenate ion has one Lewis structure that obeys the octet rule:

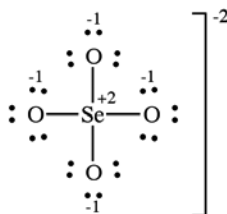

Including double bonds to two of the oxygens lowers the formal charge of Se from +2 to 0. Six resonance forms include this contribution.

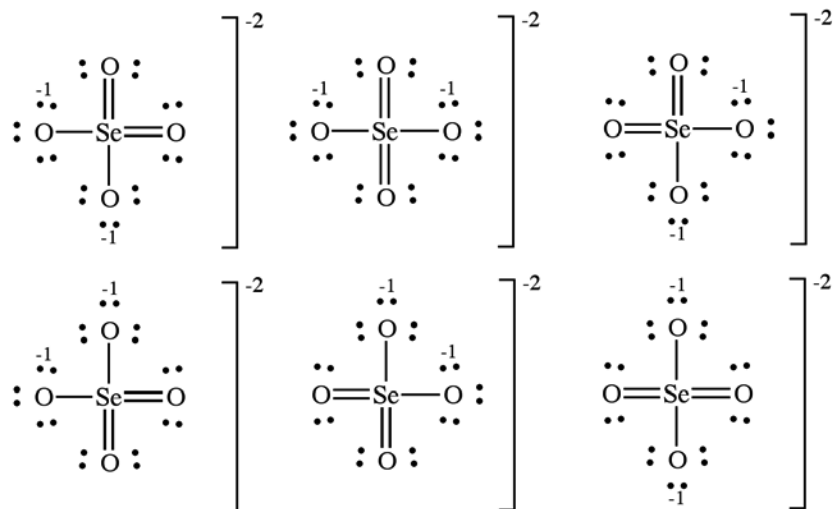

## 2C.6

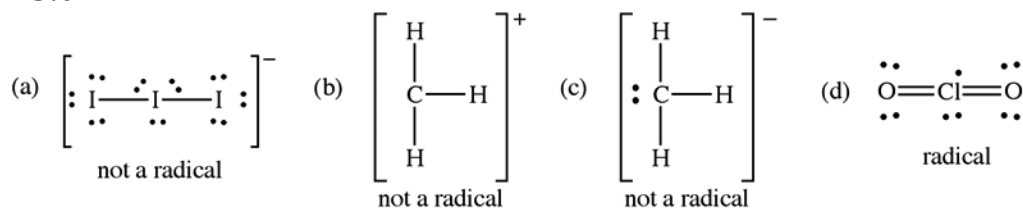

## 2C.8

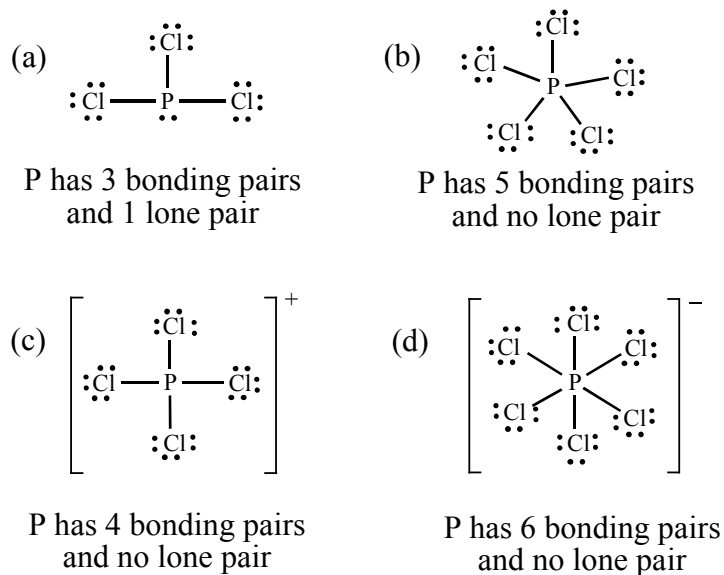

## 2C.10

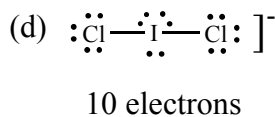
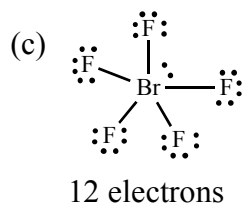
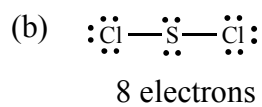
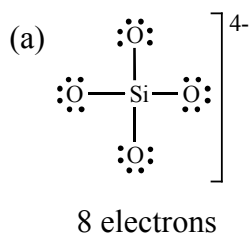

## 2C.12

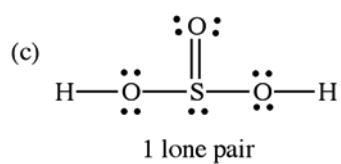
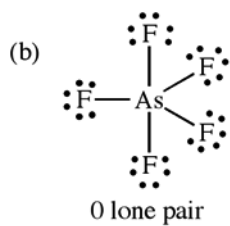
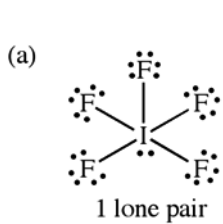

2C.14 (a) In  $\text{SF}_6$ , there are 12 electrons around the central sulfur:

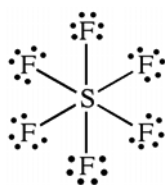

(b) In  $\text{BH}_3$  there are only six electrons around the central B:

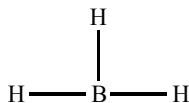



## 2C.16

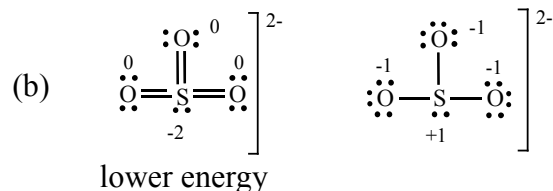
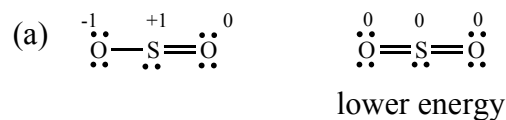

**2C.18** (a) The formal charge distribution is similar for both structures. In the first, the end nitrogen atom is  $-1$ , the central N atom is  $+1$ , and O atom is  $0$ . For the second structure, the end N atom is  $0$ , the central N atom is still  $+1$ , but the O atom is  $-1$ . The second is preferred because it places the negative formal charge on the most electronegative atom. (b) In the first structure, there are three O atoms with formal charges of  $-1$  and one O atom with a formal charge of  $0$ . The formal charge on the P atom is  $0$ . In the second structure, the P atom has a formal charge of  $-1$ ; there are two oxygen atoms with formal charges of  $-1$  and two with formal charges of  $0$ . The first structure is preferred because it places the negative formal charge at the more electronegative atom, in this case O.

**2D.2** As  $(2.18) < \text{S} (2.58) < \text{I} (2.66) < \text{Br} (2.96) < \text{O} (3.44)$ . Generally electronegativity increases as one goes from left to right across the periodic table and as one goes from heavier to lighter elements within a group.

**2D.4**  $\text{CCl}_4$  would have bonds that are primarily covalent. The electronegativity difference between C and Cl is smaller than between Ca or Cs and Cl, making the C-Cl bond more covalent.

**2D.6** (a) The N—H bond in  $\text{NH}_3$  would be more ionic; the electronegativity difference between N and H (3.04 versus 2.20) is greater than between P and H (2.19 versus 2.20). (b) N and O have similar electronegativities (3.04 versus 3.44), which leads us to expect that the N—O bonds in  $\text{NO}_2$  would be fairly covalent. The electronegativity difference between S and O is greater, so S—O bonds would be expected to be more ionic (2.58 versus 3.44). (c) Difference between  $\text{SF}_6$  and  $\text{IF}_5$  would be small because S and I have very similar electronegativities (2.58 versus 2.66). Because I has an electronegativity closer to that of F,  $\text{IF}_5$  can be expected to have more covalent bond character, but probably only slightly more, than  $\text{SF}_6$ .

**2D.8** (a) The electronegativity difference between Li and I (1.68) is greater than that between Mg and I (1.35), so LiI should be more soluble in water than  $\text{MgI}_2$ . (b) The electronegativity difference between Ca and S is 1.58, so while the difference is 2.44 between Ca and O, CaO should be more water soluble than CaS.

**2D.10**  $\text{Cs}^+ < \text{K}^+ < \text{Mg}^{2+} < \text{Al}^{3+}$ : the smaller, more highly charged cations will be the more polarizing. The ionic radii are 170 pm, 138 pm, 72 pm, and 53 pm, respectively.

**2D.12**  $\text{O}^{2-} < \text{N}^{3-} < \text{Cl}^- < \text{Br}^-$ : the polarizability should increase as the ion gets larger and less electronegative.

**2D.14** (a)  $\text{NO} > \text{NO}_2 > \text{NO}_3^-$

Bond order indicates the number of bonds between atoms. Examine the type of bond between the nitrogen and oxygen atoms by drawing Lewis structures. In NO it is a double bond (bond order of 2), in  $\text{NO}_2$  it is an average of a double and a single bond (bond order of 1.5) because of

resonance, and in  $\text{NO}_3^-$  it is an average of two single bonds and one double bond (bond order of 1.33) because of resonance.

(b)  $\text{C}_2\text{H}_2 > \text{C}_2\text{H}_4 > \text{C}_2\text{H}_6$

Examine the type of bond between the two carbon atoms by drawing Lewis structures. In  $\text{C}_2\text{H}_2$  it is a triple bond (bond order of 3), in  $\text{C}_2\text{H}_4$  it is a double bond (bond order of 2), and in  $\text{C}_2\text{H}_6$  it is a single bond (bond order of 1).

(c)  $\text{H}_2\text{CO} > \text{CH}_3\text{OH} \sim \text{CH}_3\text{OCH}_3$

Examine the type of bond between the carbon and oxygen atoms by drawing Lewis structures. In  $\text{H}_2\text{CO}$  it is a double bond (bond order of 2) and in both  $\text{CH}_3\text{OH}$  and  $\text{CH}_3\text{OCH}_3$  it is a single bond (bond order of 1).

**2D.16** Bond strength increases as bond order increases. Examine the type of bond between the carbon and nitrogen atoms by drawing Lewis structures. In  $\text{NHCH}_2$  it is a double bond (bond order of 2), in  $\text{NH}_2\text{CH}_3$  it is a single bond (bond order of 1), and in  $\text{HCN}$  it is a triple bond (bond order of 3). Therefore, the CN bond in  $\text{HCN}$  will be the strongest.

**2D.18** (a) The C—O bond in formaldehyde is a double bond, so the expected bond length will be 67 pm (double-bond covalent radius of C) + 60 pm (double-bond covalent radius of O) = 127 pm. The experimental value is 120.9 pm. (b) and (c) The C—O bonds in dimethyl ether and methanol are single bonds. The sum of the covalent single bond radii is 77 + 66 pm = 143 pm. The experimental value in methanol is 142.7 pm. (d) The C—S bond in methanethiol is a single bond. The sum of the covalent single-bond radii is thus 77 + 102 pm = 179 pm. The experimental value is 181 pm.

**2D.20** (a) The covalent radius of N is 75 pm, so the N—N single bond in hydrazine is expected to be ca. 150 pm. The experimental value is 145 pm. (b) The bond between nitrogen is a double bond; the sum of the covalent

88 Focus 2 Molecules

radii is  $60 + 60 \text{ pm} = 120 \text{ pm}$ . The experimental value in methanol is  $124 \text{ pm}$ . (c) The lowest-energy Lewis structure for azide has a double bond linking each terminal nitrogen to the central N; we would predict this molecule to have two equal bond lengths of  $60 + 60 \text{ pm} = 120 \text{ pm}$ . Experimentally, azide has been shown to possess two equal-length N—N bonds of  $116 \text{ pm}$ .

- 2E.2 (a) May have lone pairs  
 (b) Must have lone pairs

2E.4

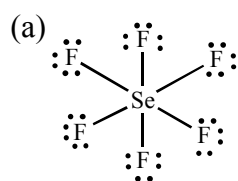

octahedral

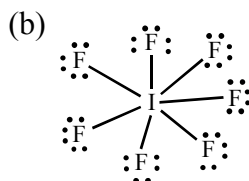

pentagonal bipyramidal

2E.6

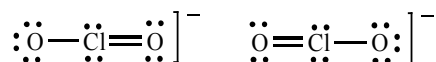

(a) The chlorite ion is angular (or bent). (b) All the oxygen atoms are equivalent (resonance forms), so there should be only one O—Cl—O bond angle; because of the presence of the two lone pairs of electrons on the central chlorine, the bond angle is expected to be  $<109.5^\circ$ .

2E.8

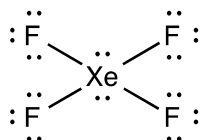

(a) The shape of the  $\text{XeF}_4$  molecule is square planar based upon an octahedral arrangement of electrons about the Xe atom. (b)  $90^\circ$ .

## 2E.10

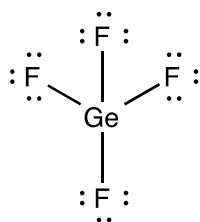

(a) Tetrahedral; (b)  $109.5^\circ$

## 2E.12

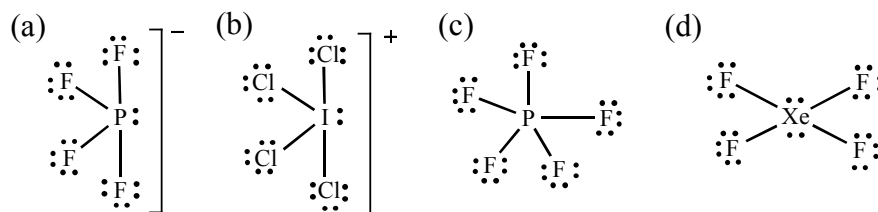

(a) The phosphorus atom in  $\text{PF}_4^-$  will have five pairs of electrons about it. There will be four bonding pairs and one lone pair. The arrangement of electron pairs will be trigonal bipyramidal with the lone pair occupying an equatorial position in order to minimize e-e repulsions. The name of the shape ignores the lone pairs, so the molecule is best described as having a seesaw structure.  $\text{AX}_4\text{E}$  (b) The number and types of lone pairs are the same for  $[\text{ICl}_4]^+$  as for  $\text{PF}_4^-$ . The structural arrangement of electron pairs and name are the same as in (a).  $\text{AX}_4\text{E}$  (c) As in (a), the central P atom has five pairs of electrons about it, but this time they all are bonding pairs. The arrangement of pairs is still trigonal bipyramidal, but this time the name of the molecular shape is the same as the arrangement of electron pairs. The molecule is therefore a trigonal bipyramid.  $\text{AX}_5$  (d) Xenon tetrafluoride will have six pairs of electrons about the central atom, of which two are lone pairs and four are bonding pairs. These pairs will adopt an octahedral geometry, but because the name of the molecule ignores the lone pairs, the structure will be called square planar. The lone pairs are

90 Focus 2 Molecules

placed opposite each other rather than adjacent, to minimize e-e repulsions between the lone pairs.  $AX_4E_2$

2E.14 The Lewis structures:

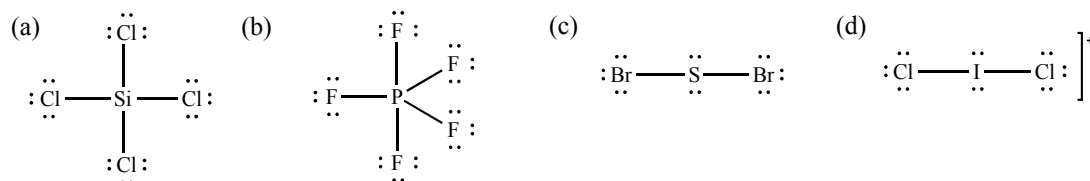

(a)  $SiCl_4$  has an  $AX_4$  VSEPR formula resulting in a molecular shape that is tetrahedral with angles of  $109.5^\circ$ . (b)  $PF_5$  has an  $AX_5$  VSEPR formula resulting in a molecular shape of trigonal bipyramidal;  $F-P-F$  bond angles are  $90^\circ$  and  $120^\circ$ . (c)  $SBr_2$  is  $AX_2E_2$ , resulting in an angular molecular shape with  $Br-S-Br$  bond angles of  $<109.5^\circ$ . (d)  $ICl_2^+$  is  $AX_2E_2$ , resulting in an angular molecular shape with  $Cl-I-Cl$  bond angles of  $<109.5^\circ$ .

2E.16 The Lewis structures:

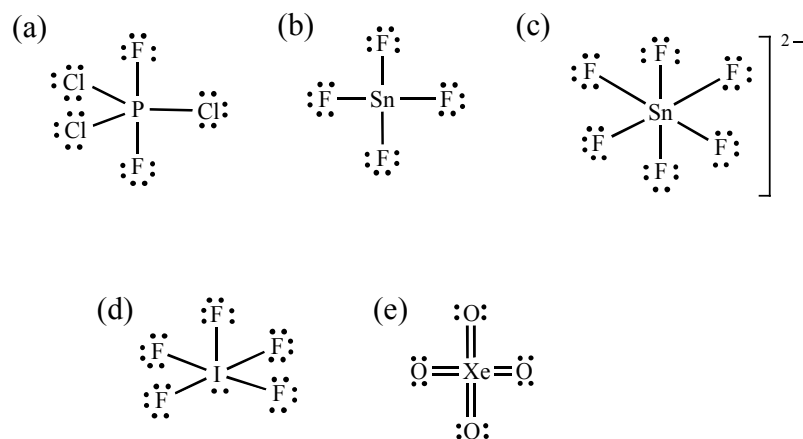

(a)  $PCl_3F_2$  is trigonal bipyramidal with angles of  $120^\circ$ ,  $90^\circ$ , and  $180^\circ$ .

The most symmetrical structure is shown with all Cl atoms in equatorial positions. Phosphorus pentahalide compounds with more than one type of

halogen atom like this have several possible geometrical arrangements of the halogen atoms. These different arrangements are known as isomers. For this type of compound, the energy differences between the isomers are low, so that the compounds exist as mixtures of isomers that are rapidly interconverting.  $AX_5$  (or  $AX_3X'_2$ ). (b)  $SnF_4$  is tetrahedral with  $F-Sn-F$  bond angles of  $109.5^\circ$ .  $AX_4$ . (c)  $SnF_6^{2-}$  is octahedral with  $F-Sn-F$  bond angles of  $90^\circ$  and  $180^\circ$ .  $AX_6$ . (d)  $IF_5$  is square pyramidal with  $F-I-F$  angles of approximately  $90^\circ$  and  $180^\circ$ .  $AX_5E$ . (e)  $XeO_4$  is tetrahedral with angles equal to  $109.5^\circ$ .  $AX_4$

**2E.18** (a) slightly less than  $109.5^\circ$ ; (b) slightly less than  $109.5^\circ$ ; (c) slightly less than  $120^\circ$ ; (d) slightly less than  $109.5^\circ$

**2E.20** The Lewis structures are:

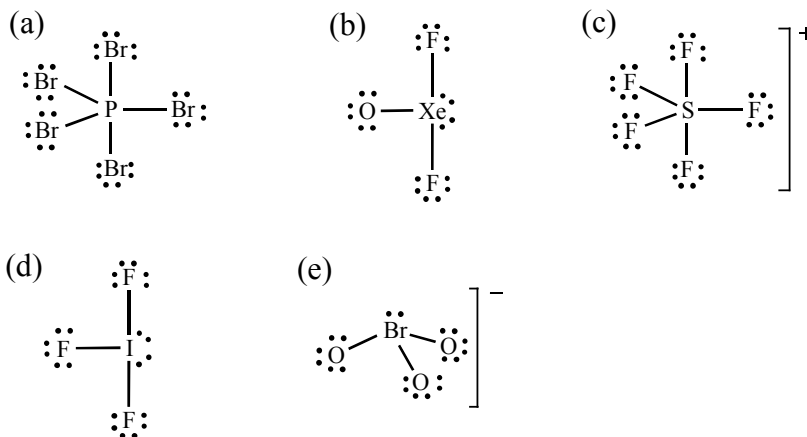

(a) No lone pairs on central atom; trigonal bipyramidal;  $90^\circ$ ,  $120^\circ$   
 (b) Two lone pairs on central atom; T-shaped;  $90^\circ$ ,  $180^\circ$   
 (c) No lone pairs on central atom; trigonal bipyramidal;  $90^\circ$ ,  $120^\circ$   
 (d) Two lone pairs on central atom; T-shaped;  $90^\circ$ ,  $180^\circ$   
 (e) One lone pair on central atom, trigonal pyramidal;  $107^\circ$

**2E.22** The Lewis structures:

92 Focus 2 Molecules

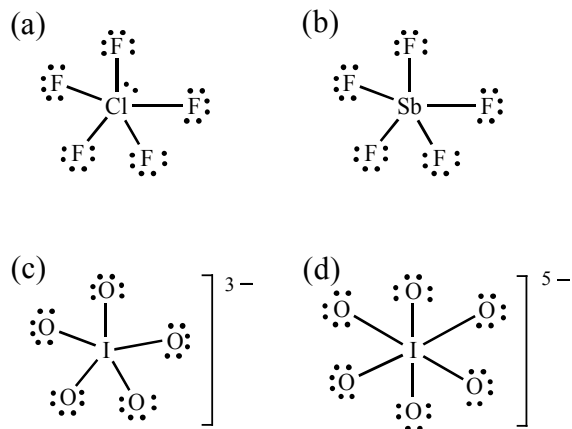

(a) square pyramidal; (b) trigonal bipyramidal; (c) trigonal bipyramidal; (d) octahedral

2E.24 The Lewis structures:

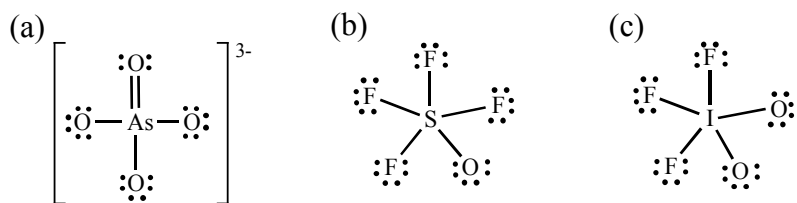

(a) tetrahedral; (b) trigonal bipyramidal; (c) trigonal bipyramidal

2E.26 The Lewis structures:

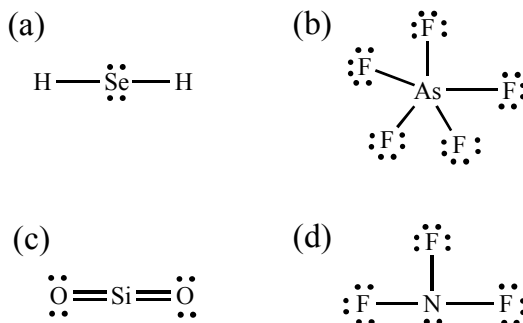

Molecules (a) and (d) will be polar; (b) and (c) will be nonpolar.



## 2E.28

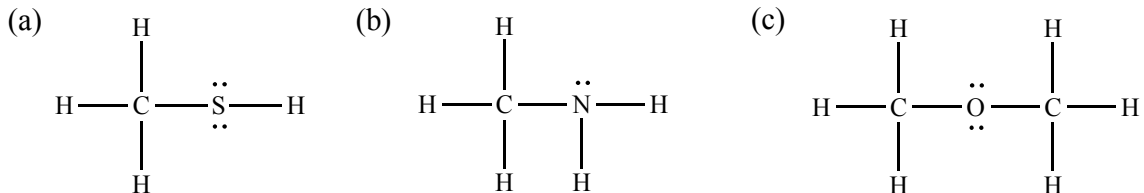

All of the compounds are polar.

**2E.30** (a) In **2** the C—H and C—F bond vectors oppose identical bonds on opposite ends of the molecule; the individual dipole moments will cancel so that **2** will be nonpolar. This is not true for either **1** or **3**, which will both be expected to be polar. (b) Assuming the C—F and C—H polarities are the same in molecules **1** and **3**, one can carry out a vector addition of the individual dipole moments. It is perhaps easiest to look at the resultant of the two F—C dipoles and the two C—H dipoles in each molecule. The dipoles will sum as shown:

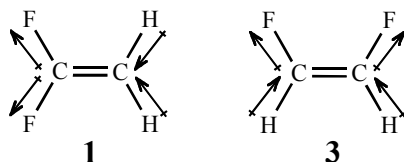

Addition of 2 C—F and 2 C—H dipoles in **1** and **3** give:

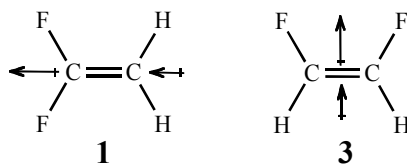

Net dipoles:

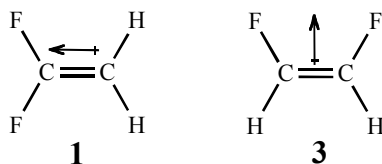

The net C—F and C—H dipoles reinforce in both these molecules, but because the F—C—F and H—C—H angles in **3** are more acute, the magnitude of the resultant will be slightly larger for **3**.

94 Focus 2 Molecules

2F.2 (a)  $sp^3$  (b)  $sp^3d$  (c)  $sp^3d^2$  (d)  $sp$

2F.4 (a) 1  $\sigma$  bond. 1  $\pi$  bond (b) 2  $\sigma$  bonds. 2  $\pi$  bonds

2F.6 (a)  $sp^3d^2$  (b)  $sp^3$  (c)  $sp^2$  (d)  $sp^2$

2F.8 (a)  $sp$  (b)  $sp^2$  (c)  $sp^2$  (d)  $sp^3$

2F.10 (a)  $sp$  (b)  $sp^3$  (c)  $sp$  (d)  $sp^2$

2F.12 The Lewis structure of  $P_2$  is similar to that of  $N_2$ :



However, P is a larger atom than N, so the P—P bond is longer, resulting in poorer overlap and therefore making a weaker and more reactive bond

2F.14

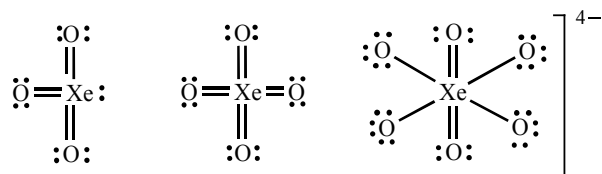

The first two molecules have four groups around the central atom, leading to tetrahedral dispositions of the bonds and lone pairs.  $\text{XeO}_3$  is of the  $\text{AX}_3\text{E}$  type and will be pyramidal, whereas  $\text{XeO}_4$  will be of the  $\text{AX}_4$  type and will be tetrahedral. The  $\text{XeO}_6^{4-}$  ion will be octahedral. The hybridizations will be  $sp^3$ ,  $sp^3$ , and  $sp^3d^2$ , respectively.

The Xe—O bonds should be longest in  $\text{XeO}_6^{2-}$  because each of those bonds should have a bond order of ca.  $(4 \times 1 + 2 \times 2)/6 = 1.5$ , whereas the bond orders in  $\text{XeO}_3$  and  $\text{XeO}_4$  will be about 2. This agrees with experiment:  $\text{XeO}_3$ , 174 pm;  $\text{XeO}_4$ , 176 pm;  $\text{XeO}_6^{2-}$ , 186 pm.

**2F.16** (a) In the  $\text{NH}_2^+$  molecule, there is a single lone pair of electrons on the central N atom, and as a result, the hybridization about the N atom is  $sp^2$ . In  $\text{NH}_2^-$ , there are two lone pairs of electrons on the central N atom and the hybridization about this atom is best described as  $sp^3$ . (b) The N  $2p_x$  orbital contributes to bonding in the  $\text{NH}_2^-$  molecule (all p-orbitals participate in the hybrid orbitals), but the N  $2p_x$  orbital does not contribute to bonding in  $\text{NH}_2^+$ . In this molecule, the N  $2p_x$  orbital lies normal to the plane containing the bonds and the lone pair; that is, there is no overlap between the N  $2p_x$  and the orbitals responsible for bonding and the orbital containing the lone pair of electrons.

**2F.18** The Lewis structure of formamide:

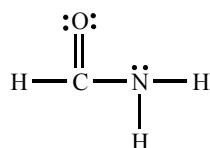

Here, both the C and the O are  $sp^2$  hybridized while the N is  $sp^3$  hybridized. The H—C—O, H—C—N, and O—C—N bond angles are each  $120^\circ$ ; the molecule has five sigma bonds (one each connecting the H's to the C and the N, one connecting the N to the C, and one O to the C). Finally, there is one pi bond (between the C and the O).

**2F.20** If we take the hybrid orbital to be  $N \cdot h_1$ , then normalization requires that:

$$\int (N \cdot h_1)^2 d\tau = 1$$

solving for N:

$$N^2 \cdot \int h_1^2 d\tau = N^2 \cdot \int (s + p_x + p_y + p_z)^2 d\tau = 1$$

Expanding this expression we find that the only terms that are not zero are:

96 Focus 2 Molecules

$$N^2 \cdot \int s^2 + p_x^2 + p_y^2 + p_z^2 \, d\tau = N^2 \cdot 4 = 1$$

$$\text{Therefore, } N = \sqrt{\frac{1}{4}} = \frac{1}{2}$$

and the normalized wavefunction is  $\frac{1}{2}h_1$

2F.22

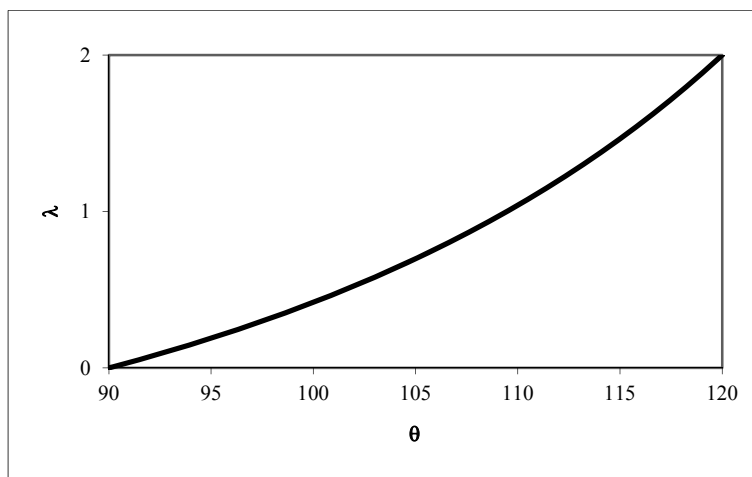

2G.2 The MO energy diagrams for  $B_2$ ,  $B_2^-$ , and  $B_2^+$  are

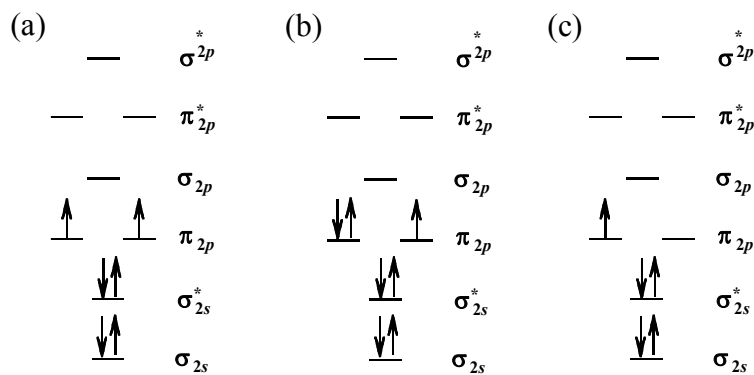

(a)  $B_2$  bond order =  $\frac{1}{2} (2 + 2 - 2) = 1$  Paramagnetic, 2 unpaired electrons

(b)  $B_2^-$  bond order =  $\frac{1}{2} (2 + 3 - 2) = 3/2$  Paramagnetic, one unpaired electron

(c)  $B_2^+$  bond order =  $\frac{1}{2} (2 + 1 - 2) = 1/2$  Paramagnetic, one unpaired electron

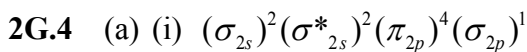

$$(ii) (\sigma_{2s})^2(\sigma_{2s}^*)^2(\pi_{2p})^4$$

$$(iii) (\sigma_{2s})^2(\sigma_{2s}^*)^2(\pi_{2p})^4(\sigma_{2p})^2(\pi_{2p}^*)^2$$

(b) (i) 2.5

(ii) 2

(iii) 2

(c) (i) and (iii) are paramagnetic

(d) (i)  $\sigma$

(ii)  $\pi$

(iii)  $\pi$

**2G.6** The charge on  $B_2^-$  is  $-1$  and the bond order is 1.5

$$\left( \text{bond order} = \frac{1}{2}(2 + 3 - 2) = 1.5 \right)$$

**2G.8**  $B_2$  is the only other period 2 homonuclear diatomic molecule that is expected to be paramagnetic because of the two unpaired electrons in the  $\pi_{2p}$  molecular orbitals.

**2G.10** (a) In molecular orbital theory, ionic and covalent bonding are extremes of the same phenomenon. According to molecular orbital theory, bonding occurs when at least one orbital on each of two atoms combines to form a bonding and antibonding set of molecular orbitals. If the orbitals on each atom that are used to make the molecular orbital are similar in energy, the resultant molecular orbitals will be composed almost equally of contributions from the two atoms. The result is a covalent bond. On the other hand, if the two orbitals that make up the molecular orbitals are quite different in energy, the bond will be highly polarized. The more electronegative atom will contribute more to the bonding orbital, and the more electropositive atom will contribute more to the antibonding orbital.

(b) The electronegativity of an atom is reflected in the energy of its

**98 Focus 2 Molecules**

atomic orbitals. The more electronegative the atom, the lower the orbitals. As the electronegativity difference becomes larger, the atomic orbitals on the two atoms being combined to form the molecular orbitals become farther apart in energy, so that the bond becomes more polarized.

**2G.12** (a)  $O_2^{2-}$  (14 valence electrons):  $(\sigma_{2s})^2(\sigma_{2s}^*)^2(\sigma_{2p})^2(\pi_{2p})^4(\pi_{2p}^*)^4$ , bond order = 1

(b)  $N_2^-$  (11 valence electrons):  $(\sigma_{2s})^2(\sigma_{2s}^*)^2(\pi_{2p})^4(\sigma_{2p})^2(\pi_{2p}^*)^1$ , bond order = 2.5

(c)  $C_2^-$  (9 valence electrons):  $(\sigma_{2s})^2(\sigma_{2s}^*)^2(\pi_{2p})^4(\sigma_{2p})^1$ , bond order = 2.5

**2G.14**

NO  $(\sigma_{2s})^2(\sigma_{2s}^*)^2(\pi_{2p})^4(\sigma_{2p})^2(\pi_{2p}^*)^1$ ; bond order = 2.5

$NO^+$   $(\sigma_{2s})^2(\sigma_{2s}^*)^2(\pi_{2p})^4(\sigma_{2p})^2$ ; bond order = 3

Because of the higher bond order for  $NO^+$ , it should form a stronger bond and therefore have the higher bond enthalpy

**2G.16**  $N_2^-$  and  $F_2^+$  have an odd number of electrons and must therefore be paramagnetic. The molecular orbital diagram for  $N_2$  shows that adding one electron will place it in a  $\pi_{2p}^*$  orbital. This will give one unpaired electron and a bond order of 2.5. The removal of an electron from  $F_2$  to give  $F_2^+$  will produce one unpaired electron in the  $\pi_{2p}^*$  orbital.  $O_2^{2+}$  will be diamagnetic, as the removal of two electrons from  $O_2$  will eliminate the two unpaired electrons.

## 2G.18

(a)  $C_2^-$  (9 valence electrons):  $(\sigma_{2s})^2(\sigma_{2s}^*)^2(\pi_{2p})^4(\sigma_{2p})^1$ , bond order = 2.5

$C_2$  (8 valence electrons):  $(\sigma_{2s})^2(\sigma_{2s}^*)^2(\pi_{2p})^4$ , bond order = 2.  $C_2^-$  will have the stronger bond.

(b)  $N_2^-$  (11 valence electrons):  $(\sigma_{2s})^2(\sigma_{2s}^*)^2(\pi_{2p})^4(\sigma_{2p})^2(\pi_{2p}^*)^1$ , bond order = 2.5

$N_2$  (10 valence electrons):  $(\sigma_{2s})^2(\sigma_{2s}^*)^2(\pi_{2p})^4(\sigma_{2p})^2$ , bond order = 3.  $N_2$  will have the stronger bond.

2G.20  $Be_2$   $(\sigma_{2s})^2(\sigma_{2s}^*)^2$ ;

$F_2$   $(\sigma_{2s})^2(\sigma_{2s}^*)^2(\sigma_{2p})^2(\pi_{2p})^4(\pi_{2p}^*)^4$ ;

$B_2^+$   $(\sigma_{2s})^2(\sigma_{2s}^*)^2(\pi_{2p})^1$ ;

$C_2^+$   $(\sigma_{2s})^2(\sigma_{2s}^*)^2(\pi_{2p})^3$ ;

Electron affinity is the measure of the energy released when an electron is added to an atom, molecule, or ion; the larger the electron affinity, the easier it is to add an electron to that species. In  $F_2$  the added electron enters an antibonding orbital, and in  $C_2^+$  it enters an orbital that contains another electron. The positive charge of  $B_2^+$  increases its electron affinity relative to  $Be_2$

2G.22 Given the overlap integral  $S = \int \Psi_{A1s} \Psi_{B1s} d\tau$ , the bonding orbital

$\Psi = \Psi_{A1s} - \Psi_{B1s}$ , and the fact that the individual atomic orbitals are

normalized, we are asked to find the normalization constant  $N$ . That will normalize the bonding orbital  $\Psi$  such that:

$$\int N^2 \Psi^2 d\tau = N^2 \int (\Psi_{A1s} - \Psi_{B1s})^2 d\tau = 1$$

$$N^2 \int (\Psi_{A1s} - \Psi_{B1s})^2 d\tau = N^2 \int (\Psi_{A1s}^2 - 2\Psi_{A1s} \Psi_{B1s} + \Psi_{B1s}^2) d\tau =$$

$$N^2 \left( \int \Psi_{A1s}^2 d\tau - 2 \int \Psi_{A1s} \Psi_{B1s} d\tau + \int \Psi_{B1s}^2 d\tau \right)$$





## 2.6

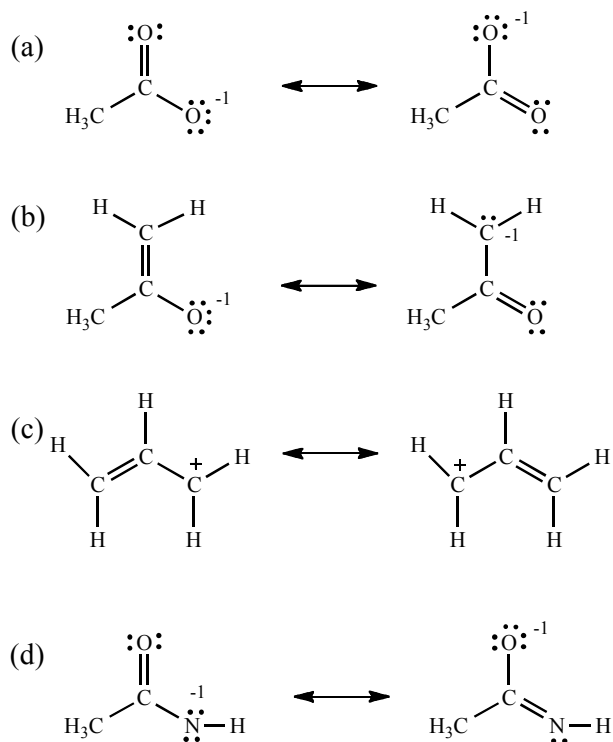

## 2.8

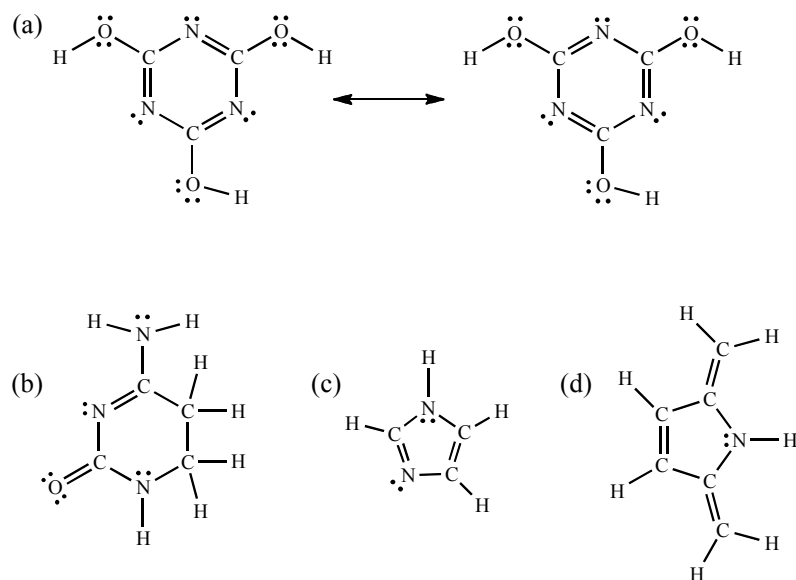

**2.10** There are seven equivalent resonance structures for the tropyllium cation. All the C—C bonds will have the same bond order, which will be the

## 102 Focus 2 Molecules

average of 4 single bonds and 3 double bonds to give an average bond order of 1.4.

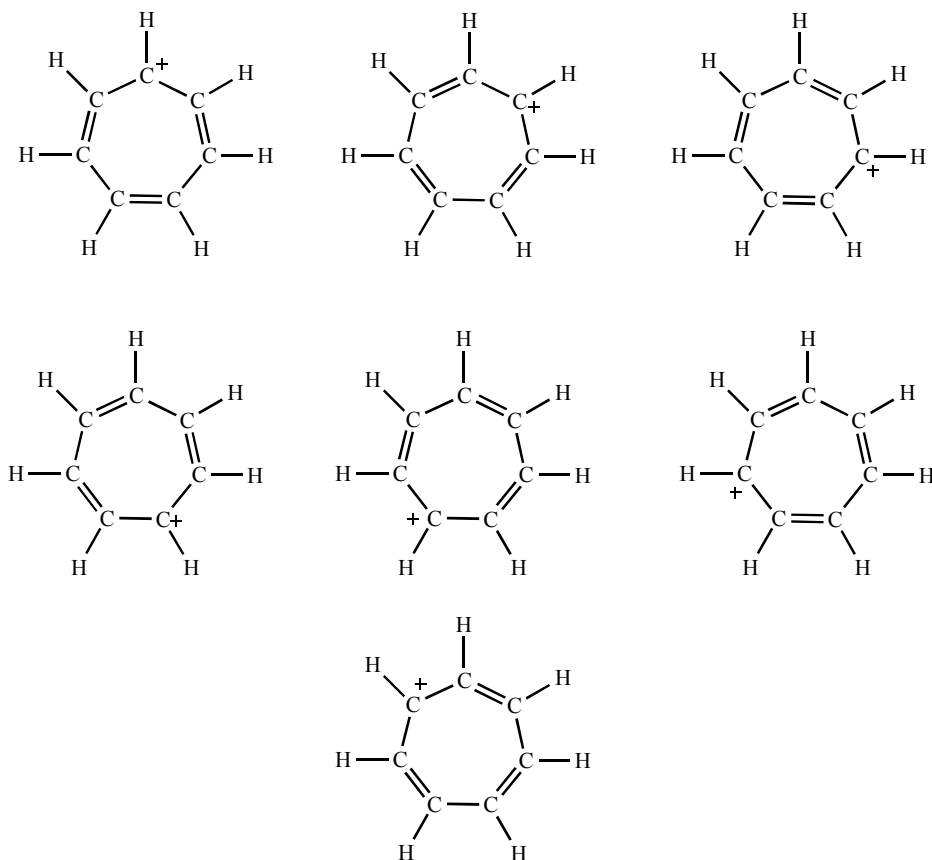

**2.12** Draw Lewis structures for all four molecules:

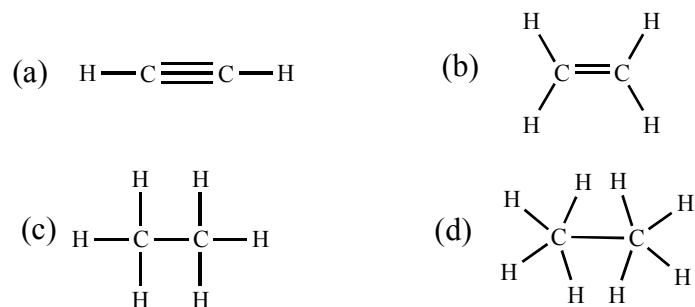

Of these, compound (d) is the only one that cannot exist (carbon cannot expand its octet).

**2.14** In (a) and (b) all atoms have formal charges of 0;

(c)  $\text{N} = 0$ ,  $\text{O} (\text{single bond}) = -1$ ,  $\text{O} (\text{double bond}) = 0$ .

## 2.16

(a)	Metal	$d(\text{M-I})$ , pm	$(1 - d^*/d)/d$	Lattice Energy, $\text{kJ} \cdot \text{mol}^{-1}$
	Li	274	$3.19 \times 10^{-3}$	759
	NaI	294	$3.00 \times 10^{-3}$	700
	KI	329	$2.72 \times 10^{-3}$	645
	RbI	345	$2.61 \times 10^{-3}$	632
	CsI	361	$2.51 \times 10^{-3}$	601

A high correlation ( $R^2 = 0.9731$ ) exists between lattice energy and  $d(\text{M-I})$ . A better fit ( $R^2 = 0.9847$ ) is obtained between lattice energy and  $(1 - d^*/d)/d$ .

(b) Using the equation  $\text{L.E.} = 218331(1 - d^*/d)/d + 54.887$  and the Ag-I distance (309 pm), the estimated AgI lattice energy is  $683 \text{ kJ} \cdot \text{mol}^{-1}$ .

(c) There is not close agreement between the estimated ( $683 \text{ kJ} \cdot \text{mol}^{-1}$ ) and experimental ( $886 \text{ kJ} \cdot \text{mol}^{-1}$ ) lattice energies. A possible explanation is that the  $\text{Ag}^+$  ion is more polarizable than the alkali metal cations of similar size, so the bonding in AgI is more covalent.

**2.18** The potential energy well is deepest for  $\text{N}_2$  ( $\text{N} \equiv \text{N}$ ), then  $\text{N}_3^-$  ( $\text{N} = \text{N}$ ), then  $\text{N}_2\text{H}_4$  ( $\text{N} - \text{N}$ ):

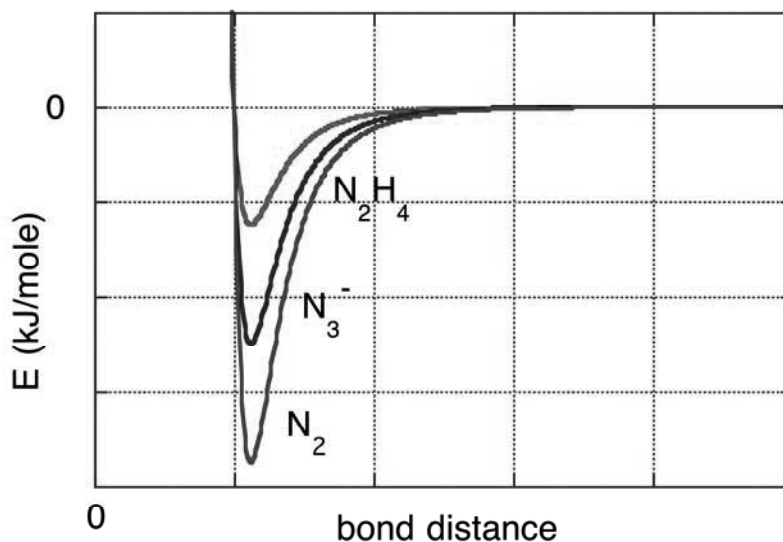

- 2.20 (a) Mulliken defined electronegativity as  $\chi = \frac{1}{2}(IE + EA)$ ; using the values for C, N, O, and F found in Figure 2.24 and 2.28 and dividing by 230 kJ/mol, we get the following Pauling's values (Figure 3.12) are shown for comparison:

Element	Z	Mulliken Electronegativity	Pauling Electronegativity
C	6	2.6	2.55
N	7	3.0	3.04
O	8	3.2	3.44
F	9	4.4	3.98

- (b) A plot of electronegativity versus Z for these two scales yield the following:

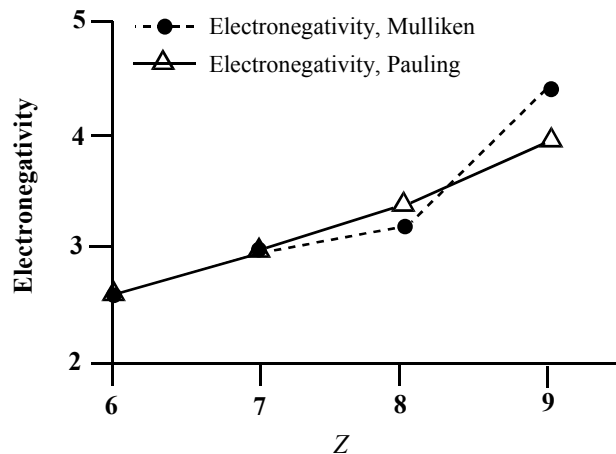

(c) The two scales are relatively close to one another, as the plot in part (b) shows. The Pauling values seem to be a little more consistent, as a steady rise is seen from carbon to fluorine; the Mulliken values, while showing a general increase over the same range of  $Z$  also show a dip at oxygen and a spike at fluorine.

2.22 (a) A reasonable Lewis structure for  $S_6$ :

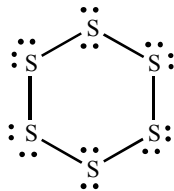

(b) A possible resonance structure for  $S_6$  can be drawn:

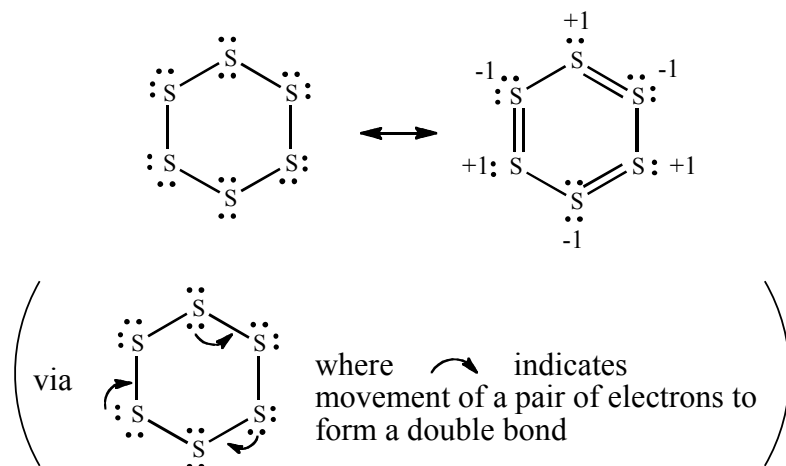

## 106 Focus 2 Molecules

This resonance structure have higher energy than the  $S_6$  ring with no double bonds and will therefore contribute little (if any) to the stability of the molecule.

**2.24** In each case, the more ionic pair will have the lower vapor pressure.

(a)  $Na_2O$ ; (b)  $InCl_3$ ; (c)  $LiH$ ; (d)  $MgCl_2$

**2.26** (a) The  $BrO$  bond in  $BrO^-$  would be expected to be longer. The  $Br-O$  bond in  $BrO^-$  is a single bond, but  $BrO^{2-}$  contains one single bond and one double bond, so it will be shorter. (b) The  $SiH$  bond in  $SiH_4$  would be expected to be longer. Bond distance increases with atomic size. Silicon is larger than carbon, so it would be expected to have the longer bond.

**2.28** (a) The  $XX'$  molecules will be simple diatomic molecules with an  $X-X'$  single bond. The  $XX'_3$  molecules will have a central atom of the VSEPR type  $AX_3E_2$ . The molecule will therefore be T-shaped. The  $X'-X-X'$  bond angles will be slightly less than  $90^\circ$  and  $180^\circ$ . The  $XX'_5$  molecules will have central atoms of the type  $AX_5E$ , which will be a square pyramidal structure with bond angles of ca.  $90^\circ$  and  $180^\circ$ . (b) All three types will be polar. (c) The central atom is the one that is the least electronegative. A consideration of the oxidation numbers shows that the central atom is the one that is positive, and the atoms around it are negative. Thus, the central atom will be the one that retains its electrons less effectively.

**2.30**

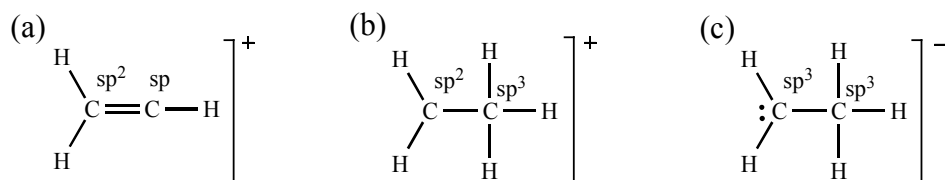

- 2.32 (a) The helium and hydrogen atoms have only their 1s orbitals available for bonding. Combination of these two will lead to a  $\sigma$  and a  $\sigma^*$  pair of orbitals. The most stable species will be one in which only the  $\sigma$  orbital is filled. Thus we need a species that has only two electrons. The charge on this species will be +1. (b) The maximum bond order will be 1. (c) Adding one electron will decrease the bond order by 1/2 because an antibonding orbital will be populated. Taking an electron away will also decrease the bond order by half because it will remove one bonding electron.

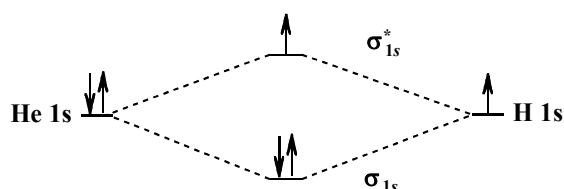

- 2.34 The Lewis structures that contribute to the structure of the carbamate ion:

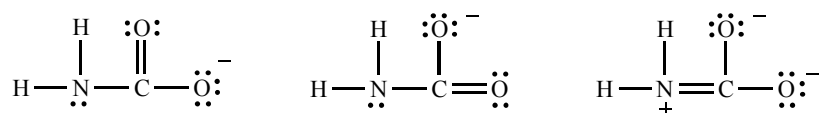

The charges show the location of the formal charges on the atoms in the Lewis structure. The form that has a double bond to N is a zwitterion, a structure that contains a positive and a negative charge in the same molecule. We might expect this structure to have a higher energy and contribute less to the overall structure than the other two forms, which have less separation of charge and which are equivalent in energy. To get insight into this question, we can compare the observed bond distances (C—O, 128 pm, C—N, 136 pm) to those expected for various C—O and C—N bond orders. We can estimate these values using the data given in Table 2D.3 and Figure 2D.11. The following values are obtained:

Bond	Expected Bond Length, pm
C—O	151
C=O	112, 127
C—N	152
C=N	127

The C—O bond distance is very close to what we would expect for a C=O, although the average of experimental data gives a value closer to 112 pm. The second value is probably more reliable indicating that the C—O bonds in the carbamate ion are intermediate between a double and single bond. The same is true of the C—N bond, (Experimental values of C=N double bonds are close to 127 pm.) It appears, then, that the resonance form with a C=N double bond does contribute substantially to the structure.

- 2.36** The three possible forms that maintain a valence of 4 at carbon are cyclopropene, propyne, and allene, which have these structures, respectively:

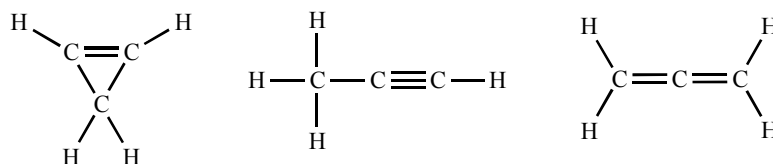

The C—C—C bond angles in cyclopropene are restricted by the cyclic structure to be approximately  $60^\circ$ , which is far from the ideal value of  $109.47^\circ$  for an  $sp^3$ -hybridized carbon atom, or  $120^\circ$  for an  $sp^2$ -hybridized C atom. Consequently, cyclopropene is a very strained molecule that is extremely unstable. The H—C—H bond angle at the  $CH_2$  group would be expected to be  $109.47^\circ$ , but it is actually larger because of the narrow C—C—C bond angle. The carbon of the  $CH_2$  group is  $sp^3$ -hybridized, whereas the other two carbon atoms are  $sp^2$ . Likewise the C=C—H angles, which would normally be expected to be  $120^\circ$  because of  $sp^2$  hybridization at C, are somewhat larger. In allene, the middle carbon atom is  $sp$ -hybridized; the two end carbons are  $sp^2$ -hybridized. The C—C—C bond



angle is expected to be  $180^\circ$ ; the H—C—H bond angles should be close to  $120^\circ$ . In propyne, one end carbon is  $sp^3$ -hybridized ( $109.5^\circ$  angles); the other two C atoms are  $sp$ -hybridized, with  $180^\circ$  bond angles. The three structures are not resonance structures of each other, as they have a different spatial arrangement of atoms. For two structures to be resonance forms of each other, only the positions of the electrons may be changed. These two compounds are *isomers*.

- 2.38** To show that two  $\pi$  orbitals taken together are cylindrically symmetric, we assume that the  $z$ -axis is the bonding axis and show that net probability distribution (the sum of the two molecular orbitals squared) is not a function of  $\phi$ . (Refer to Figure 2.2 to confirm that, looking down the  $z$ -axis, a cylindrically symmetric orbital will not be a function of  $\phi$ .)

$$x \cdot f(z) = f(z) \cdot C \cdot \sin \theta \cdot \cos \phi$$

$$y \cdot f(z) = f(z) \cdot C \cdot \sin \theta \cdot \sin \phi$$

where  $C = \left(\frac{3}{4\pi}\right)^{\frac{1}{2}}$ , and  $f(z)$  is not a function of  $x$  or  $y$  (and, therefore,

$f(z)$  is not a function of  $\phi$ ). Squaring the two wavefunctions and summing them:

$$f(z)^2 C^2 \sin^2 \theta \cos^2 \phi + f(z)^2 C^2 \sin^2 \theta \sin^2 \phi = f(z)^2 C^2 \sin^2 \theta (\cos^2 \phi + \sin^2 \phi)$$

Using the identity  $\cos^2 x + \sin^2 x = 1$  this becomes

$$= f(z)^2 C^2 \sin^2 \theta$$

With two electrons in each  $\pi$  orbital, the electron distribution is not a function of  $\phi$  and is, therefore, cylindrically symmetric about the bonding axis.

- 2.40** The overlap can be end-to-end or side-on. In the side-on overlap situation, the net overlap is zero because the areas of the wave function that are negative will cancel with the areas of the wave function that are positive. These will be equal in area and opposite in sign, giving no net overlap.

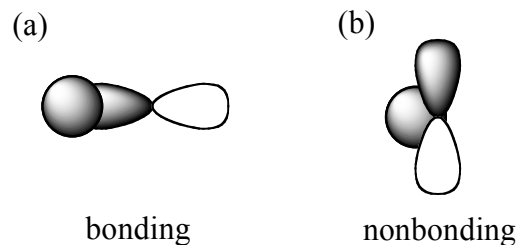

## 2.42

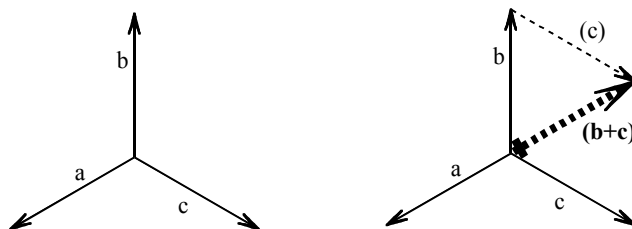

For the trigonal planar molecule, we first construct the vectors representing the individual dipole moments and then add them. This can be done most easily by combining two of the vectors first and then adding that to the third. Let's first add  $b$  and  $c$ . In order to add the vectors, we need to position them head to tail. Because the original angle where  $b$  and  $c$  come together in the  $AX_3$  molecule is  $120^\circ$ , the angle between them when the origin of  $c$  is shifted to the end of  $b$  will be  $60^\circ$ . Because that angle is  $60^\circ$  and  $b$  is the same length as  $c$ , the resultant of  $b + c$  must also have the same length as  $a$  (and  $b$  and  $c$ ). As can be seen from the diagram, the original vector  $a$  points in exactly the opposite direction from the summed vector  $b + c$ . Because the angle between  $b$  and  $b + c$  is  $60^\circ$  and the angle between  $a$  and  $b$  is  $120^\circ$ , it follows that the angle between  $a$  and  $b + c$  must be  $180^\circ$ . Because  $b + c$  has exactly the same magnitude as  $a$ , they will exactly cancel each other.

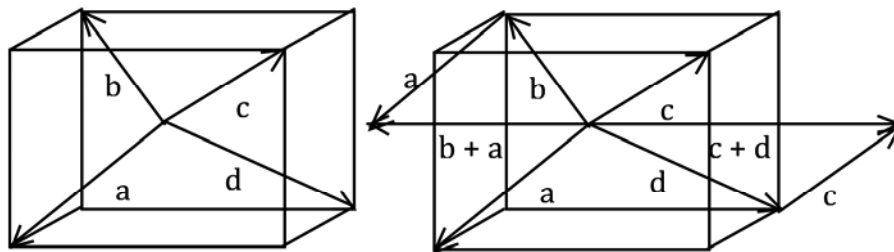

For the tetrahedron, which can be inscribed inside a cube as shown above, the vectors can be added in pairs to give resultants as shown. Starting with original vectors  $a$ ,  $b$ ,  $c$ , and  $d$ , we can add  $a + b$  and  $c + d$ . (For an ideal tetrahedron in which all the atoms bonded to the central atom are identical, the choice of which vector is  $a$ ,  $b$ ,  $c$ , or  $d$  is arbitrary because they are all equivalent.) An examination of the tetrahedron will show that the vectors  $a$  and  $b$  lie in a plane perpendicular to the plane of vectors  $c$  and  $d$ . The resultant  $c + d$  will be equal in magnitude to the resultant  $a + b$  because the vectors  $a$ ,  $b$ ,  $c$ , and  $d$  all have the same magnitude, and the angle between them is the same. It is easy to see that the vectors  $a + b$  and  $c + d$  lie exactly opposite each other and will add to zero.

- 2.44 (a) The structure of caffeine and the hybridization of each nonhydrogen atom are shown below. For the sake of clarity all lone pairs of electrons have been left out; each N in the structure has one lone pair not shown, while each O has two lone pairs not shown:

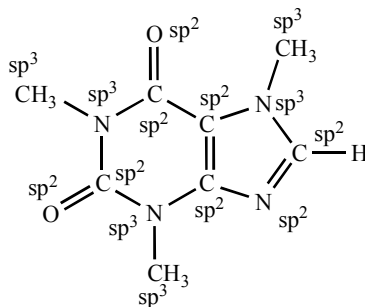

- (b) The bond angles around any atom marked  $sp^3$  should be  $109.5^\circ$  while the bond angles around any atom marked  $sp^2$  should be  $120^\circ$ .

(c) The crystal structure of caffeine is known. See "The Structures of the Pyrimidines and Purines. VII. The Crystal Structure of Caffeine." D. June Sutor. *Acta Cryst.* (1958). 11, 453-458 for bond length and angles. The experimental values compare favorably with those predicted.

## 2.46 (a)

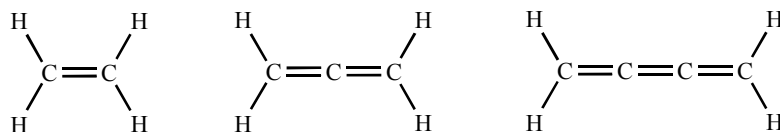

(b) The hybridization at the atoms attached to two hydrogen atoms is  $\text{sp}^2$ , whereas that at the carbon atoms attached only to two other carbon atoms is  $\text{sp}$ .

(c) Double bonds connect all of the carbon atoms to each other.

(d) The  $\text{H}-\text{C}-\text{H}$  and  $\text{C}-\text{C}-\text{H}$  angles should all be ca.  $120^\circ$ . The  $\text{C}-\text{C}-\text{C}$  angles will all be  $180^\circ$ .

(e) The hydrogen atoms in  $\text{H}_2\text{CCH}_2$  and  $\text{H}_2\text{CCCCH}_2$  lie in the same plane, whereas the planes that are defined by the two end  $\text{CH}_2$  groups lie perpendicular to each other in  $\text{H}_2\text{CCCH}_2$ . This is because the  $p$  orbitals that are used by the central carbon atom to form the double bonds to the end carbon atoms are perpendicular to each other as shown. Diagram of the interaction of the  $p$  orbitals used in making the  $\text{C}-\text{C}$  double bonds:

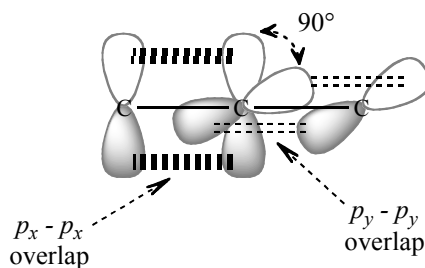
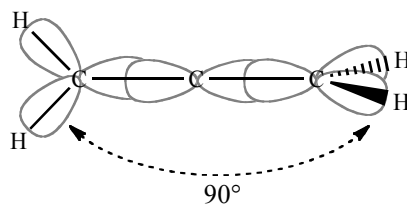

Diagram showing the orientation of the  $\text{sp}^2$  orbitals used for bonding to the H atoms:



The three different p-orbitals are commonly labeled  $p_x$ ,  $p_y$ , and  $p_z$  to distinguish them. They may be thought of as pointing in the x, y, and z directions on a set of Cartesian axes that intersect at the carbon atom. The three p-orbitals on a given carbon atom will be oriented  $90^\circ$  apart. Thus, if the central carbon atom is  $sp$ -hybridized, the  $sp$ -hybrid orbitals will be  $180^\circ$  apart (not shown) and will form the  $\sigma$  bonds to the other carbon atoms. This arrangement will use the p-orbitals on the end carbon atoms that are oriented in the same direction. (As shown here, the  $p_z$ -orbitals on all three carbons have been used.) The  $p_x$ - and  $p_y$ -orbitals on the middle carbon will be used in forming the bonds. This means that the bond to one carbon atom will be made from  $p_x$ ,  $p_x$  interactions and the bond to the other will be  $p_y$ ,  $p_y$ . One end carbon will be using the s-,  $p_z$ -, and  $p_x$ -orbitals for forming the  $sp^2$ -hybrids and the other will be using the s-,  $p_z$ -, and  $p_y$ -orbitals. This change will result in the  $sp^2$ -orbitals on the end carbons being oriented  $90^\circ$  away from each other. This orientation effect will occur only if there is an odd number of carbons in the chain. If there is an even number of carbon atoms, the end C atoms will be required to use the same type of p-orbitals as each other for forming the  $sp^2$ -hybrid orbitals. Thus  $H_2CCCCCH_2$  should have all the hydrogen atoms in the same plane, and in  $H_2CCCCCCH_2$  the planes of the end  $CH_2$  groups will again be perpendicular to each other.

(f) If x is odd, the hydrogen atoms on one end will lie in a plane perpendicular to the plane occupied by the hydrogen atoms on the other end. If x is even, all of the hydrogen atoms will be coplanar.

**2.48** (a) The hybridization for each C and N atom is as follows:

114 Focus 2 Molecules

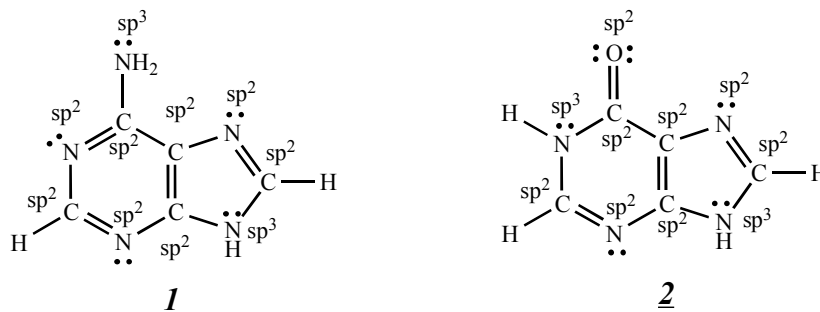

- (b) 1 has 16  $\sigma$  bonds and 4  $\pi$  bonds; 2 has 15  $\sigma$  bonds and 4  $\pi$  bonds.  
 (c) There are 5 lone pairs of electrons in 1 and 6 lone pairs in 2.

2.50 The germide ion  $\text{Ge}_4^{n-}$  has the following structure:

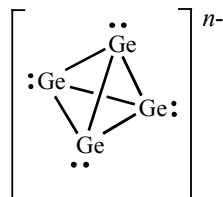

This structure has a total of 20 electrons used as either lone or bonding pairs; four Ge atoms can provide only 16 of these electrons (4 Ge atoms at 4 valence electrons per Ge), meaning there must be four extra electrons. Therefore  $-n = -4$ .

2.52 Other answers are also possible; to be isoelectronic both species only need to have the same number of total valence electrons.

- (a)  $\text{BF}_3$  and  $\text{CO}_3^{2-}$  are isoelectronic (24 valence electrons); both are trigonal planar.  
 (b)  $\text{SO}_2$  and  $\text{O}_3$  are isoelectronic (18 valence electrons); both are bent (with central atom bond angles of  $\approx 120^\circ$ ).  
 (c)  $\text{HBr}$  and  $\text{OH}^-$  are isoelectronic (8 valence electrons); both are linear.

2.54

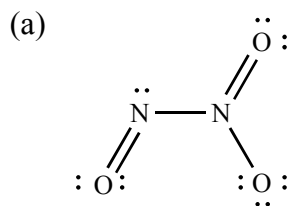

(b) The bond order between the 2 nitrogens is 1. (c) Nitrogen is unable to have an expanded octet, whereas phosphorus can have an expanded octet. Thus you will see different structures between the two.

2.56 (a) The Lewis structures:

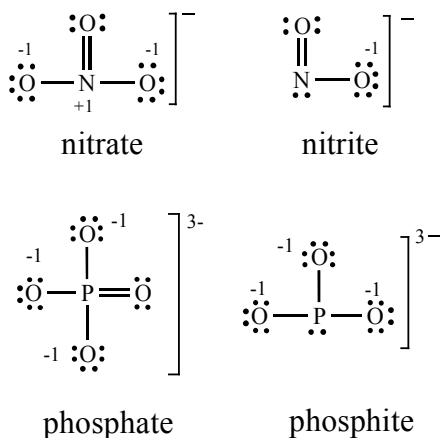

Both phosphite and nitrite have standard Lewis structures; upon oxidation each picks up one more oxygen. Phosphate is able to expand its octet to accommodate 10 electrons around it while nitrate cannot. In doing so phosphate can eliminate both a positive and a negative formal charge, thus lowering its overall energy:

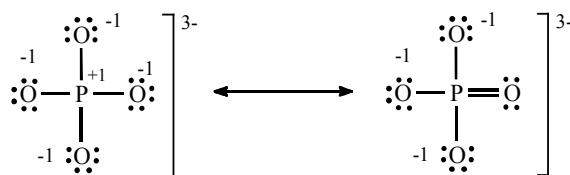

This ability of P to expand its octet is due to the presence of unoccupied  $3d$  orbitals. Nitrogen, which is a Period 2 element does not have  $d$  orbitals and therefore cannot expand its octet.

(b) Phosphate ions can form chains in which one phosphate can be linked to another (polyphosphates or phosphate anhydrides):

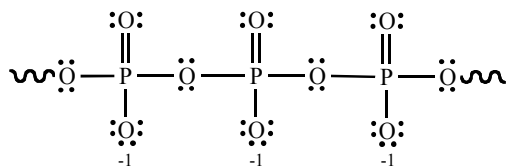

Nitrate, on the other hand, cannot form such species; presumably, this is because formation of a polynitrate would require placing a number of positive charges relatively close to one another, an unfavorable arrangement:

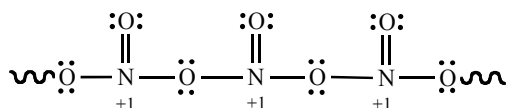

2.58

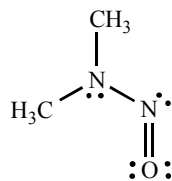

2.60

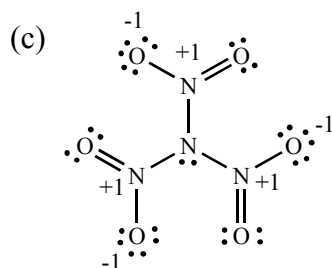
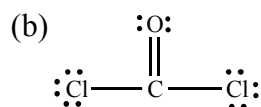
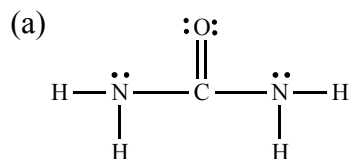



**2.62** (a) The angles represented by a and b are expected to be about  $120^\circ$  while c is expected to be about  $109.5^\circ$  in 2, 4-pentanedione. All of the angles are expected to be about  $120^\circ$  in the acetylacetonate ion.

(b) The major difference arises at the C of the original  $sp^3$ -hybridized  $CH_2$  group, which upon deprotonation and resonance goes to  $sp^2$  hybridization with only three groups attached (the double-headed arrow is read as “in resonance with”):

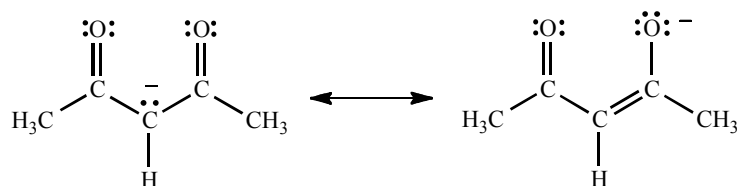

**2.64** The Lewis structure of hydroxylamine:

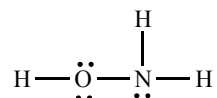

The hybridization of both the oxygen and the nitrogen is  $sp^3$ . All bonds in hydroxylamine are  $\sigma$ -bonds; there are no  $\pi$ -bonds present. Because of the presence of the lone pairs on oxygen and nitrogen, both the  $H-O-N$  and the  $O-N-H$  angles are less than their predicted  $109.5^\circ$ .

**2.66** (a) The Lewis structure of hydrogen peroxide is

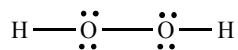

No atoms have formal charges, and the oxidation number of each O is  $-1$ . Oxidation number is more useful than formal charge in predicting the oxidizing ability of a compound, as this will give us a clearer idea of whether a given atom wants to gain or lose an electron.

(b) The bond angles should be about the same as that for water, ca.  $104^\circ$ . All atoms in this molecule are in the same plane, but because of unrestricted rotation around the  $O-O$  bond, it is expected that the hydrogens (and therefore the lone pairs of electrons on the oxygens) can

rotate in and out of the plane; one of these rotations will lead to a polar structure. (The different forms, arising from rotations around a single  $\sigma$  bond, are called *rotomers*.) Because of this, the molecule is expected to be polar, but slightly less so than water.

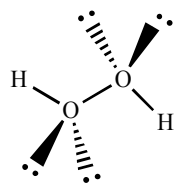

planar, nonpolar  
rotomer

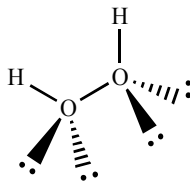

planar, polar  
rotomer

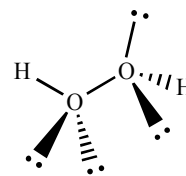

nonplanar, polar  
rotomer (one of many)

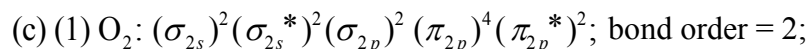

paramagnetic.

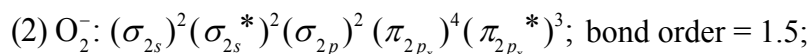

paramagnetic.

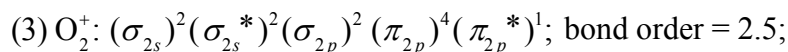

paramagnetic.

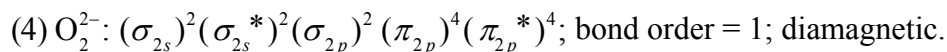

(d) Bond length should inversely follow bond order; therefore, the longest bond should belong to the molecule with the lowest bond order ( $O_2^{2-}$ ), and the shortest bond should belong to the species with the largest bond order ( $O_2^+$ ), which is borne out in the data.

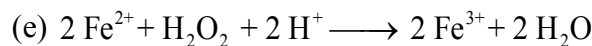

$$43.2 \text{ mL } H_2O_2 \times \frac{1 \text{ L}}{1000 \text{ mL}} \times \frac{0.200 \text{ mol } H_2O_2}{1 \text{ L}} = 8.64 \times 10^{-3} \text{ mol } H_2O_2$$

$$8.64 \times 10^{-3} \text{ mol } H_2O_2 \times \frac{2 \text{ mol } Fe^{2+}}{1 \text{ mol } H_2O_2} \times \frac{2 \text{ mol } Fe^{3+}}{2 \text{ mol } Fe^{2+}} \times \frac{55.85 \text{ g } Fe^{3+}}{1 \text{ mol } Fe^{3+}} = 0.965 \text{ g } Fe^{3+}$$

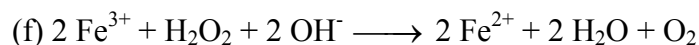

$$41.8 \text{ mL H}_2\text{O}_2 \times \frac{1 \text{ L}}{1000 \text{ mL}} \times \frac{0.200 \text{ mol H}_2\text{O}_2}{1 \text{ L}} = 8.36 \times 10^{-3} \text{ mol H}_2\text{O}_2$$

$$8.36 \times 10^{-3} \text{ mol H}_2\text{O}_2 \times \frac{2 \text{ mol Fe}^{3+}}{1 \text{ mol H}_2\text{O}_2} \times \frac{2 \text{ mol Fe}^{2+}}{2 \text{ mol Fe}^{3+}} \times \frac{55.85 \text{ g Fe}^{2+}}{1 \text{ mol Fe}^{2+}} = 0.934 \text{ g Fe}^{3+}$$

(g) Two electrons are transferred.

(h) The homolytic cleavage of hydrogen peroxide to form hydroxyl radicals is:

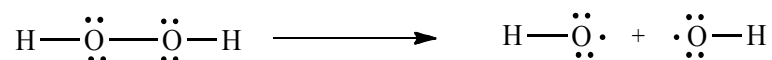

The energy required to break this bond is 157 kJ/mol. To break a single O—O will take:

$$\frac{157 \text{ kJ}}{1 \text{ mol O—O bonds}} \times \frac{1 \text{ mol O—O bonds}}{6.022 \times 10^{23} \text{ O—O bonds}} \times \frac{1000 \text{ J}}{1 \text{ kJ}}$$

$$= 2.61 \times 10^{-19} \text{ J per O—O bond}$$

$$\nu = \frac{E}{h} = \frac{2.61 \times 10^{-19} \text{ J}}{6.626 \times 10^{-34} \text{ J}\cdot\text{sec}} = 3.94 \times 10^{14} \text{ Hz}$$

$$\lambda = \frac{c}{\nu} = \frac{2.998 \times 10^8 \text{ m}\cdot\text{s}^{-1}}{3.94 \times 10^{14} \text{ s}^{-1}} = 7.61 \times 10^{-7} \text{ m} = 761 \text{ nm}$$

